



E I C H H O L T Z

110984 WALL LAMP WATERLOO SINGLE

ASSEMBLY INSTRUCTION

- 1** Turn off the electricity supply at the main circuit panel before installing. Do not connect the electricity supply until your luminaire is fully assembled and installed. Fix the crossbar (A) to the wall by using wall mounting plugs and screws suitable to your wall type.

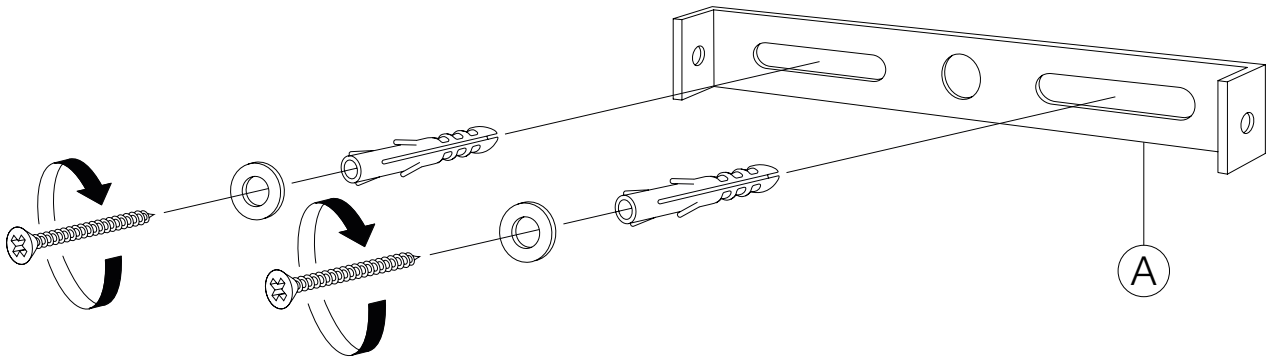

- 2** Connect the 3 wires according to their colours. Brown is the live wire, blue is the neutral wire, green/yellow is the earth wire.

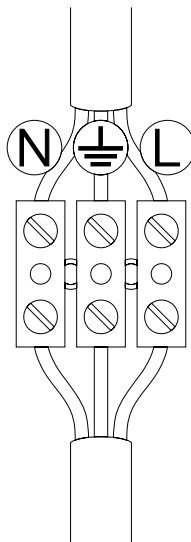

- 3** Slide the lamp over the crossbar.

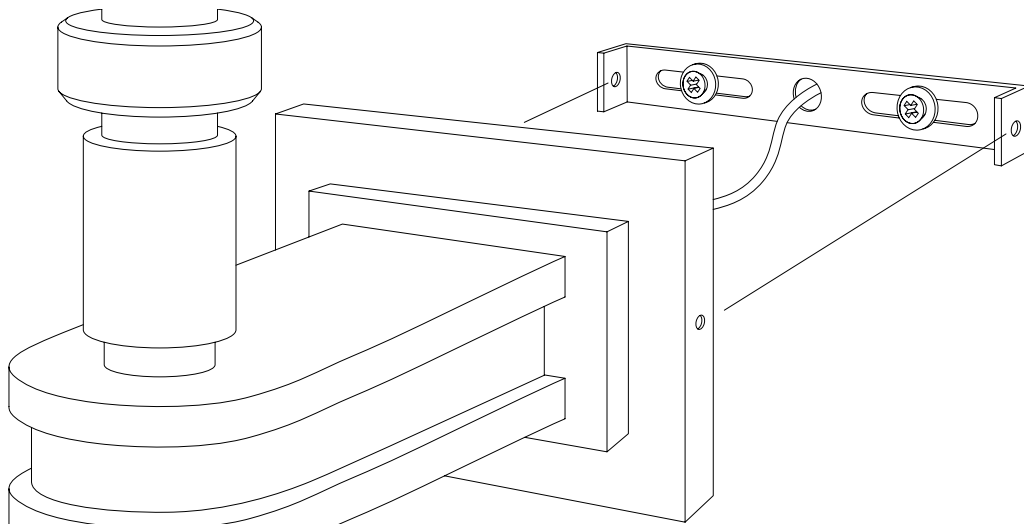



E I C H H O L T Z

110984 WALL LAMP WATERLOO SINGLE

ASSEMBLY INSTRUCTION

- 4 Fix the lamp securely with the allen screws (B) supplied and place the bulb.

